

# ACCESORIOS PARA INSTALACIÓN DE CAMPANAS ACCESSORIES FOR PROPER COOKER HOODS INSTALLATION

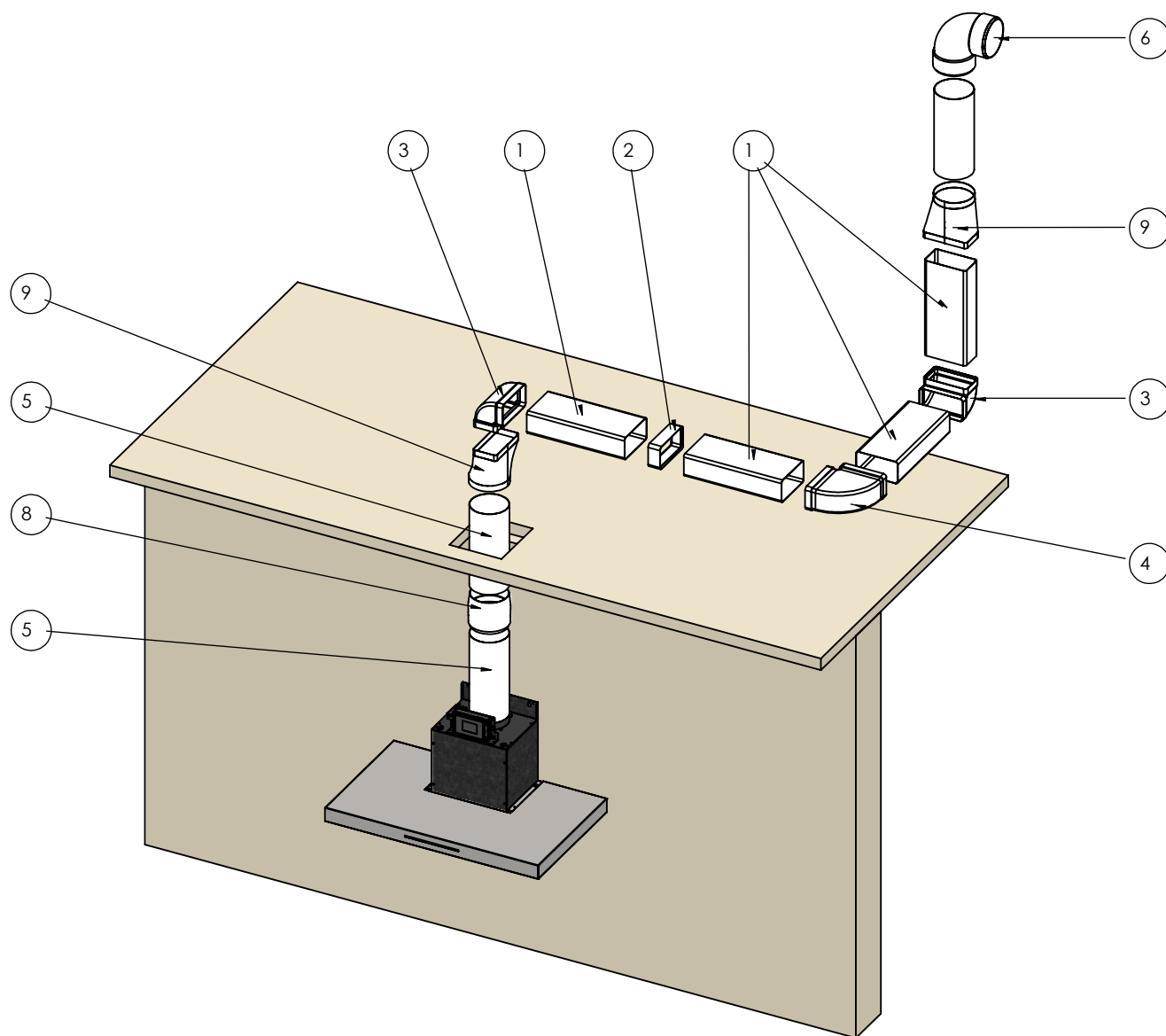

### Rectangular / Rectangular 180x90

1

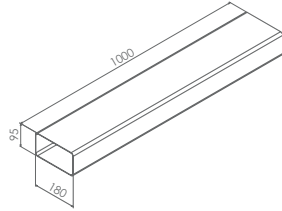

Tubo rectangular  
Rectangular duct  
180 x 90 mm L= 1000 mm

Ref.	P.V.R.
009809	44 €

2

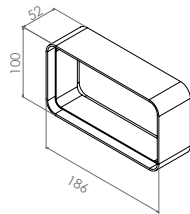

Empalme rectangular  
Straight connector  
180 x 90 mm

Ref.	P.V.R.
010437	14 €

4

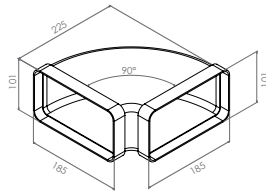

Codo rectangular horizontal 90° \*  
Straight bend 90°  
180 x 90 mm

Ref.	P.V.R.
010439	28 €

9

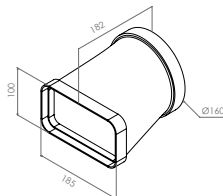

Convertidor Ø150  
Connector  
90x180

Ref.	P.V.R.
009310	33 €

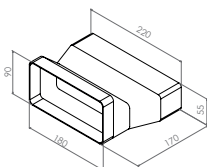
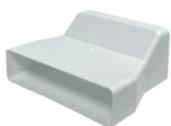

Adaptador  
220x55 / 180x90

Ref.	P.V.R.
010104	33 €

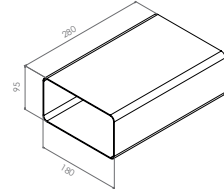
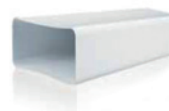

Conducto rectangular  
Rectangular duct  
180 x 90 mm L= 280 mm

Ref.	P.V.R.
640064500088	22 €

3

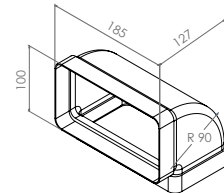
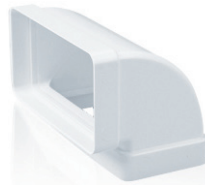

Codo rectangular vertical 90° \*  
Vertical bend 90°  
180 x 90 mm

Ref.	P.V.R.
010438	22 €

7

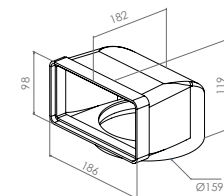

Codo vertical redondo  
a rectangular. Curva 180x90 mm  
Mixed 180x90mm  
Ø150 mm

Ref.	P.V.R.
010440	39 €

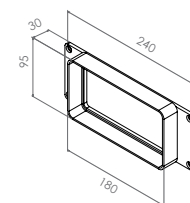

Soporte  
90x220 (marco)  
90x180 (salida)

Ref.	P.V.R.
640064500070	20 €

### Rectangular / Rectangular 220x90

**1**

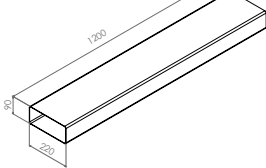
Tubo rectangular  
Rectangular duct  
220 x 90 mm L= 1200 mm

Ref.	P.V.R.
009813	49 €

**2**

Empalme rectangular  
Straight connector  
220 x 90 mm

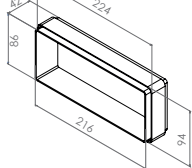
Ref.	P.V.R.
009814	19 €

**3**

Codo rectangular vertical 90°  
Vertical bend 90°  
220 x 90 mm

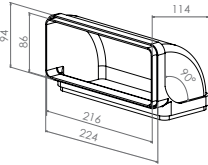
Ref.	P.V.R.
009815	28 €

**4**

Codo rectangular horizontal 90°  
Straight bend 90°  
220 x 90 mm

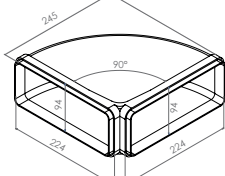
Ref.	P.V.R.
010441	33 €

Soporte  
90x220  
Marco salida

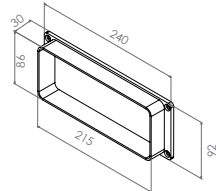
Ref.	P.V.R.
640064500081	20 €

**9**

Convertidor recto Ø150 mm / 220 x 90 mm  
Mixed straight connector

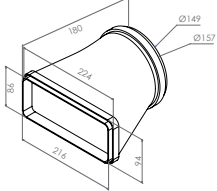
Ref.	P.V.R.
009905	59 €

**7**

Codo redondo a rectangular  
Ø150 90x220 90°  
convertidor

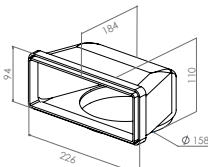
Ref.	P.V.R.
640064500079	49 €

Adaptador  
220x55 / 220x90

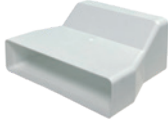
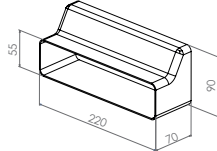
Ref.	P.V.R.
640064500121	44 €

### Rectangular / Rectangular 220x55

Tubo rectangular  
Rectangular duct  
220 x 55 mm L: 1000 mm

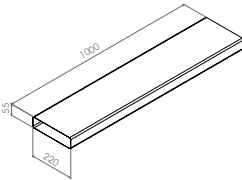
Ref.	P.V.R.
010100	49 €

Codo rectangular vertical 90°  
Vertical bend 90°  
220 x 55 mm

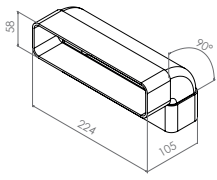
Ref.	P.V.R.
640064500111	44 €

Codo rectangular horizontal 90°  
Horizontal bend 90°  
220 x 55 mm

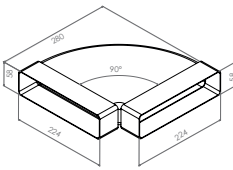
Ref.	P.V.R.
010101	49 €

Empalme rectangular  
Straight connector  
220 x 55 mm

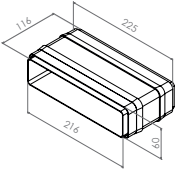
Ref.	P.V.R.
010442	44 €

### Rectangular / Rectangular 220x55 (cont.)



Codo vertical redondo a rectangular  
220x55 / Ø125 / 90°

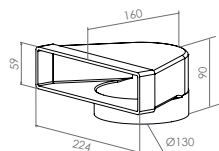

Ref.	P.V.R.
640064500116	60 €



Empalme  
220x55 / Ø125

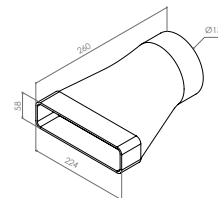

Ref.	P.V.R.
010102	55 €

### Circular / Circular Ø150

5



Tubo redondo  
Circular Duct  
Ø150 mm L= 1000 mm

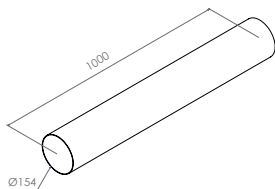

Ref.	P.V.R.
009817	39 €

8



Empalme redondo  
Ø150

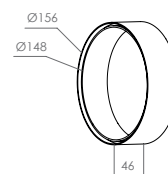

Ref.	P.V.R.
009601	22 €

6



Codo redondo  
Ø150

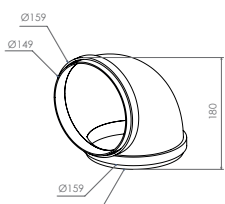

Ref.	P.V.R.
009308	39 €



Aro reductor  
Reducer ring  
Ø150 a Ø120 mm

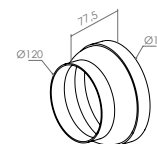

Ref.	P.V.R.
640064500012	19 €

### Rectangular / Rectangular 230x80



Convertidor  
80x230  
90x220

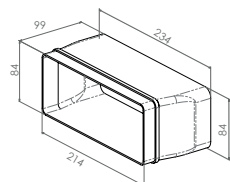

Ref.	P.V.R.
640064500080	49 €



Ajuste aro  
80x230  
salida

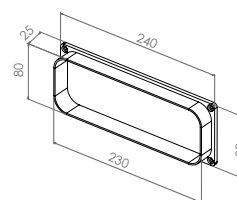

Ref.	P.V.R.
640064500033	60 €



Convertidor  
80x230  
Ø150

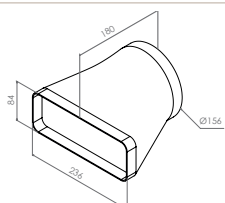

Ref.	P.V.R.
640064500053	66 €

# VÁLVULAS ANTI-RETORNO, VENTANILLAS Y REJILLAS BACKDRAFT SHUTTERS, WINDOWS AND VENTS



## Válvulas de cierre anti-retorno Backdraft shutters

Características: Compuerta antiretorno metálica para instalar en la descarga de los ventiladores. Impiden la entrada de olores, corrientes de aire y evitan fugas de calefacción cuando el extractor no funciona.

Features: metal backdraft shutters to install at the exit delivery. Prevents from the entry of odours, air streams and heating leaks from the outside when the extractor is not on.

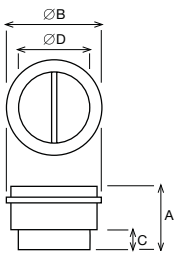

	A	Ø B	C	Ø D	Ref.	P.V.R.
Ø 125 mm	107	139	31,5	119,5	006723	100 €
Ø 150 mm	121	163,5	35	147	006724	110 €
Ø 160 mm	121	173,5	35	157	006725	115 €
Ø 200 mm	131,5	214	35	197,5	006726	125 €



## Ventanillas de apertura por sobrepresión Wall outlet with gravity flat

Características: Persiana de sobrepresión construida en material termoplástico, estabilizado contra los rayos UV. Resistencia a los flujos abrasivos.

Features: Overpressure blind manufactured in thermoplastic material, stabilized against UV rays. Resistance to abrasive flows.

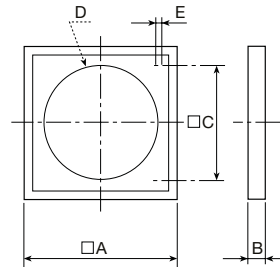

	Ø A	B	C	Ø D	Ø E	Ref.	P.V.R.
Ø 130 mm	158	15	110	130	4	006711	75 €
Ø 152 mm	178	20	130	152	4	006712	105 €
Ø 205 mm	243	21	184	205	5	006713	135 €



Rejillas exteriores INOX.  
Outdoor grills in S/Steel with backdraft shutter

	Ref.	P.V.R.
Ø 150 mm	008769	175 €
Ø 200 mm	008770	200 €

Características: Realizada en INOX, tiene una doble función: impide la entrada de corrientes de aire, y por otra parte, su rejilla exterior protege de la entrada de cuerpos extraños dentro del conducto.

Features: Made of stainless steel, with a dual function: prevents the entry of air streams, while its outside grill protects from the entry of foreign objects inside the duct.

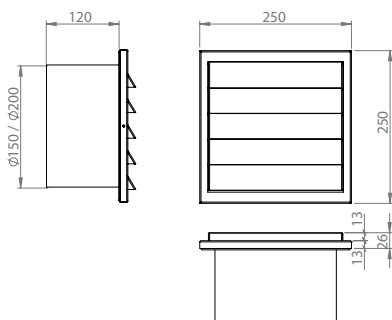

Rejilla final tubo rectangular PVC  
PVC ventilation grill for rectangular ducting

	Ref.	P.V.R.
180 x 90 mm	009850	30 €

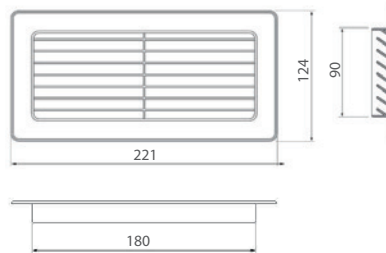

Rejilla final tubo rectangular PVC  
PVC ventilation grill for rectangular ducting

	Ref.	P.V.R.
220 x 90 mm	010417	40 €

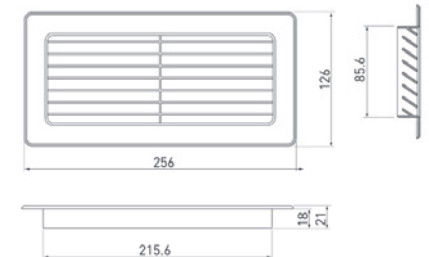

## Tubo silenciador para conducto Silencer tube for pipe



Descripción / Description	mm				Ref.	P.V.R.
	Ø A	Ø B	C	D		
Ø 160 mm	160	250	600	700	009952	435 €
Ø 200 mm	200	300	600	700	009953	545 €

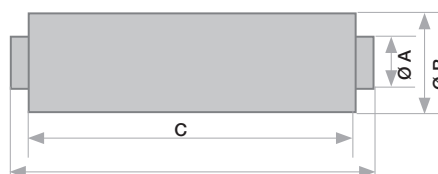

## Caja soporte insonorizada para motores de tejado Soundproof support box for roof motors

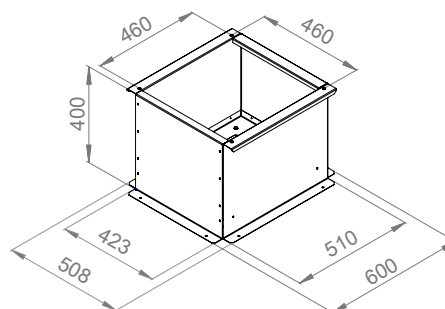

Ref.	P.V.R.
008624	290 €

Características: Fabricada en acero galvanizado, interior del plenum con sistema de insonorización S.E.C. System by Pando, ideal para reducir la pérdida de caudal y disminuir el nivel sonoro. Aconsejable para instalaciones de conducto que tengan un recorrido de campana a motor inferior a 4 m.

Features: Manufactured in galvanized steel, plenum interior has S.E.C. soundproof system System by Pando, ideal to reduce the loss of flow and to reduce the noise level. Recommended for piping installations with a distance of less than 4 m from hood to motor.

## Tarifa de precios de campanas Inox esmaltadas epoxy Epoxy enamelled cooker hood price list

	C O L O R P I N T U R A			
	Blanco RAL 9003 White	Negro RAL 9005 Black	Negro satinado Satin Black	Negro texturado Textured Black
CAMPANAS INOX PARED DECORATIVE COOKER HOODS WALL	295 €	295 €	325 €	350 €
CAMPANAS INOX ISLA DECORATIVE COOKER HOODS ISLAND	360 €	360 €	390 €	420 €
CAMPANAS INOX TECHO PEQUEÑAS DECORATIVE COOKER HOODS CEILING SMALL (E-290 y/and E-295)	295 €	295 €	325 €	350 €
CAMPANAS INOX TECHO DECORATIVE COOKER HOODS CEILING (RESTO MODELOS / ALL REMAINING MODELS)	360 €	360 €	390 €	420 €
CAMPANAS DE FORMATO ESPECIAL SPECIAL SIZE COOKER HOODS	Bajo presupuesto On request	Bajo presupuesto On request	Bajo presupuesto On request	Bajo presupuesto On request