







PLB-7145

Lave-vaisselles à intégration. Pour meuble de 45 cm
Fully-integrated dishwasher. For cabinets of 45cm.

A++ * **E** **

 Programme ECO ECO Program	 Demi charge Half load	 Meuble de 45 cm Cabinets of 45 cm
 Porte à glissière Sliding door	 Range-couverts spécial Third Drawer for cutlery	
 Panier réglable en hauteur Height-adjustable upper basket	 Lumière extérieure de fonctionnement Exterior operating light	

10 Couverts de capacité Place settings	7 Programmes Programs	2 Bras gicleurs Spray arms
--	---------------------------------	--------------------------------------

Système de double lavage / Dual wash System

 Lavage Supérieur Washing Upper	 Lavage Inférieur Washing Lower	 Lavage Normal Standard Washing
--	--	--

(*) Auto | Intensif | Normal | Eco | Verrerie | 90 min. | Rapide
Auto | Intensive | Normal | Eco | Glass | 90 min. | Quick wash

Panneau de commande électronique / Electronic Control Panel

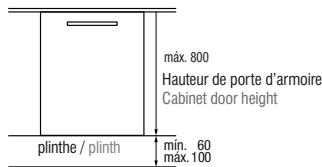

Vue de face / Front view

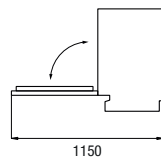

Vue de côté / Side view

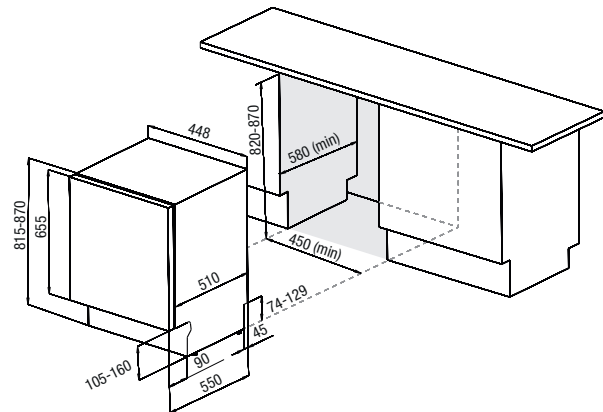

Fonctionnalités / Product features

Capacité de couverts	Service set capacity	10
Délai d'allumage	Start delay option	1-24 hrs.
Consommation d'énergie du cycle de lavage	Energy consumption per cycle	0,75 kWh
Consommation d'eau par lavage	Water consumption per cycle	8 ltrs.
Niveau sonore	Noise level	45 dB(A)
Nombre de températures	Number of temperatures	5
AquaStop - Système anti-fuite	AquaStop - Anti-leakage system	Oui / Yes
Nombre de bras gicleurs	Number of spray arms	2
Poids maximum de la porte	Weight of door panel	Min. 4 Kg. / Max. 8 Kg.

(*) Classification énergétique valable jusqu'au 28/02/2021 - RD UE 1060/2010 / Energy class valid until 28/2/2021 - RD UE 1060/2010
(**) Classification énergétique valable à partir du 1/3/2021 - RD UE 2019/2016 / Energy class valid from 1/3/2021 - RD UE 2019/2016